



NIDEC OKK CORPORATION

8-10, KITA-ITAMI, ITAMI
HYOGO 664-0831 JAPAN
International Sales Department
TEL:(81)72-771-1143
www.nidec.com/en/nidec-okk/
E-mail:nokk.ovsd@nidec.com

NIDEC OKK A DIVERSIFIED MANUFACTURER OF MACHINE TOOLS

Specializes In:

Machining centers
Graphite cutting machining centers
Grinding centers
CNC Milling machines
Conventional milling machines
Total die and mold making systems
Flexible manufacturing cells and systems

NOTE :

NIDEC OKK reserves the right to change the information contained in this brochure without notice.
NIDEC OKK is not responsible to make changes to previously sold machines or accessories.
The machines in the photographs of this brochure may include optional accessories.

The export of this product is subject to an authorization from the government of exporting country.
Check with the government agency for authorization.

NIDEC OKK USA CORPORATION
100 REGENCY DRIVE, GLENDALE HEIGHTS, IL 60139 USA
TEL:(1)630-924-9000
FAX:(1)630-924-9010

NIDEC OKK EUROPE GmbH
HANSEMANNSTR. 33 41468 NEUSS GERMANY
TEL:(49)2131-29868-0
FAX:(49)2131-29868-41

NIDEC OKK Machinery (THAILAND) Co., Ltd.
KUMTHORN HOLDING BUILDING 2nd FLOOR 897-897/1 Rama 3
Road, Bangpongpan, YANNAWA, BANGKOK 10120 THAILAND
TEL:(66)2-683-2160-2
FAX:(66)2-683-2163

NIDEC OKK (SHANGHAI) CO., LTD.
12F, TOWER B, 100 ZUNYI ROAD, CHANG NING DISTRICT,
SHANGHAI, CHINA
TEL:(86)21-62700930
FAX:(86)21-62700931



High-speed, High-accuracy
Hyper Machining Center

VP SERIES

VP 400

VP 600

VP SERIES



www.nidec.com/en/nidec-okk/

NIDEC OKK CORPORATION

Higher Speed and Higher Precision! Hyper MCs Debut to Respond to Users' Advanced Needs.

Nidec OKK's new series of hyper machining centers "VP Series" are the most efficient ever in the manufacturing fields of dies, jigs and tools that demand higher speed and precision along with the mass processing field that requires maximum productivity.

High-speed, High-accuracy
Hyper Machining Center

VP Series High Response

Standard

VP 400
VP 600



VP600



VP400

2 APC specification VP 400-2APC VP 600-2APC



VP400-2APC

● Main features

▶ Four models to choose from

Four models consisting of two standard models, and two 2APC models are available to meet specific needs of users.

▶ High performance for improved productivity

The VP Series offers the spindle rotating speed of 12000 rpm, rapid traverse speed of 48 m/min (1890 ipm) for X and Y axes and 36 m/min (1418 ipm) for Z axis, and tool change time (tool-to-tool) of 1.2 seconds.

▶ New structure and new technologies for enhanced machining accuracy. Equipped with linear roller guides. Improved fine-motion feed control and circular cutting accuracy. Minimal thermal displacement.

● The machines in the photographs of this brochure may include optional accessories.

Machining with High Accuracy

Core cooling system in the ball screw and its supports minimizes thermal displacement caused by the high-speed axis movement.

Double-anchoring method used for the ball screw support and improvement rigidity of the feed-system servo minimizes lost motion. (P6 Chart 1)

Optimum arrangement of the spindle head and the saddle ensures improved thermal stability in the Y-axis direction and improved motion rigidity. (Fig. 1)

Use of the highly-rigid linear roller guides with minimum friction coefficient has improved the fine-motion feed control and the circular cutting accuracy. (P6 Chart 2 Fig.3)

Use of the Soft Scale for compensating thermal displacement of the spindle and the HQ (High & Quick Response) control assures high and stable machining accuracy. (P6 Fig. 2)

Structure with High Rigidity

Machine main body with thick-walled box-shaped structure and further improved thermal stability of the casting as a part of a thorough thermal displacement counter-measures.

Using the double-anchoring method for the ball screw support, improves the feeding rigidity four times as high as the conventional machines.

Measures for Ecology

Grease lubrication is used for the spindle bearing and the ball screw feed guide sections.

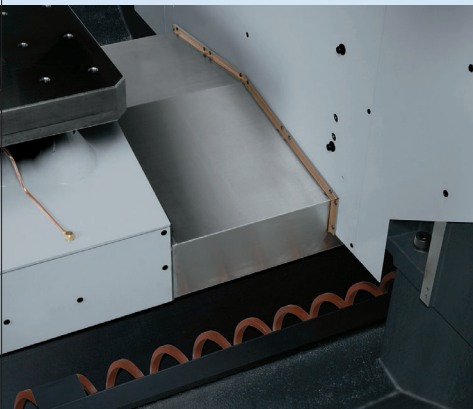
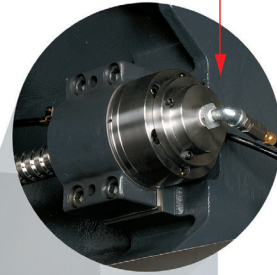
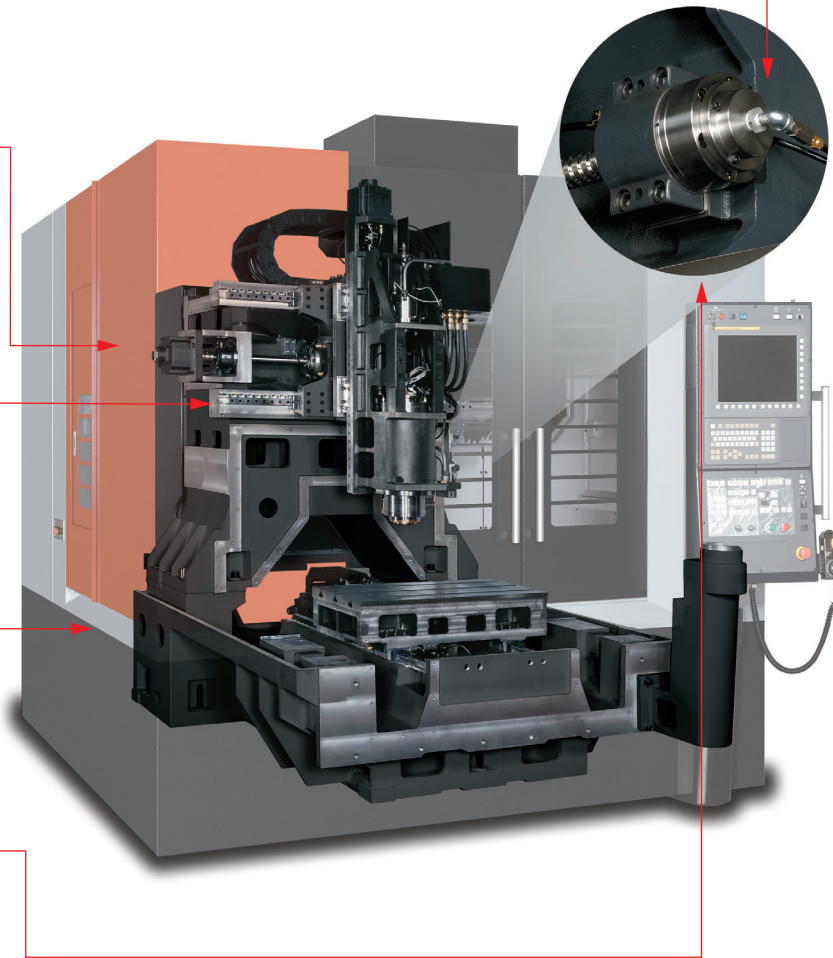

To prevent the main body structure from being exposed to coolant directly, the coolant shelter is provided as standard equipment, and all possible measures are taken against thermal displacement.

Rigidity Analysis by Finite Element Method(FEM) (Fig.1)

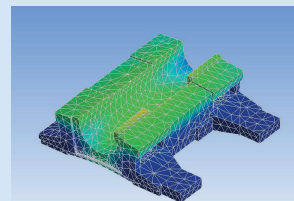
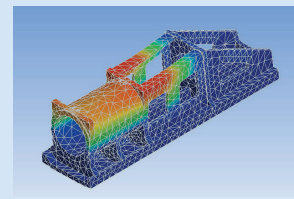
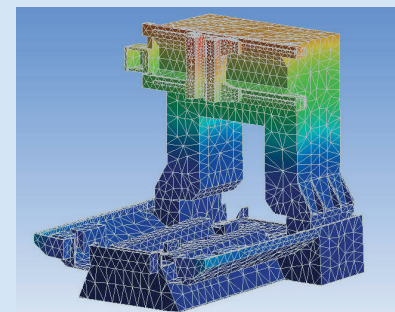

Drastically reduced workpiece machining time

Rapid traverse rate 48 m/min(1890 ipm)(X and Y)
36 m/min(1418 ipm)(Z)

Maximum feed acceleration 0.7 G

Spindle startup time 1.0s(0 → 12000 rpm)*

Tool changing time 1.2s(Tool-to-Tool)
3.8s(Cut-to-Cut)

*With optional high-pwer spindle motor

Nidec OKK's original tool changer ensures stable and high-speed operation

Tool changer adopts a Nidec OKK's original mechanism to completely synchronize between the ATC unit and the spindle and assures the stable operation and the tool changing time of 1.2 seconds (tool-to-tool) / 3.8 seconds (cut-to-cut).



Standard provision of 12000rpm spindle

Cutting performance is largely improved by the use of the motorized spindle (MS) which integrates a motor covering a wide and high output range. Acceleration time of the spindle can be as short as only 1.0 seconds(*) from the non-operating state to the speed of 12000rpm. High-speed spindle of 20000rpm 37/26/18.5kW(50/35/25HP) (FANUC)・37/26/22kW(50/35/30HP) (MITSUBISHI) high-power spindle can also be adopted optionally.

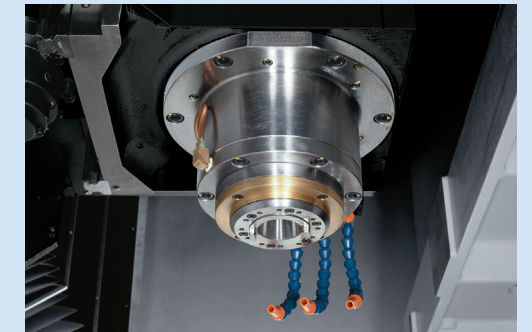

*Optional high-power spindle motor specification

Extensive tool storage capacity

In addition to the standard provision of 20-tool magazine, optionally available are 30-tool magazine and separate type magazines for 40-tool, 60-tool, 80-tool and 120-tool storage.

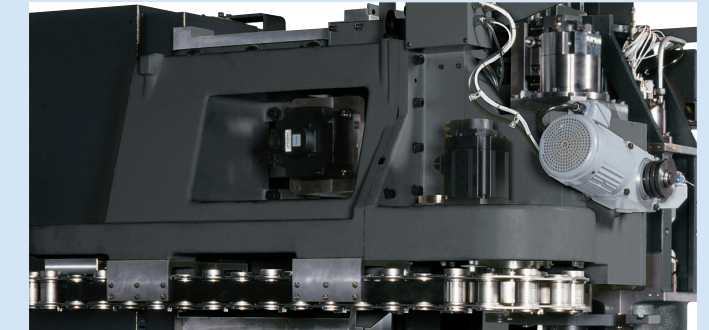

Wide machining area for versatile workpieces



VP400 table

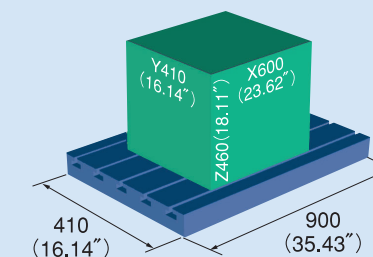

VP400

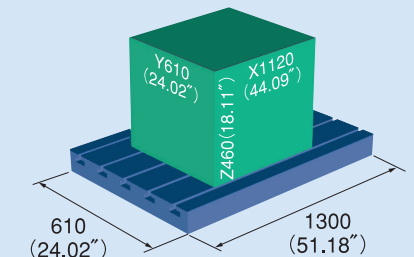

VP600

●The machines in the photographs of this brochure may include optional accessories.

Sample Cutting Data (VP600)

(Workpiece material : S45C)

Values are for reference only.

Face milling

φ100×5t (Standard spec.)
φ80×4t (High power spec.)

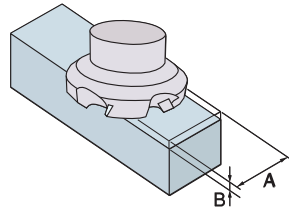

	Standard specification	High-power specification
Spindle speed	1000 rpm	1200 rpm
Cutting speed	314 m/min (8425 ipm)	300 m/min (1181 ipm)
Cutting width (A)	80 mm (3.15")	60 mm (2.36")
Cutting depth (B)	3 mm (0.12")	4 mm (0.16")
Feed rate	700 mm/min (27.56 ipm)	1450 mm/min (57.09 ipm)
Feed per tooth	0.14 mm/tooth (0.0055"/tooth)	0.3 mm/tooth (0.012"/tooth)
Cutting amount	168 cm ³ /min (10.1cu-inch/min)	348 cm ³ /min (20.9cu-inch/min)
Spindle motor load	109 %	70 %

Grooving

φ32×2t

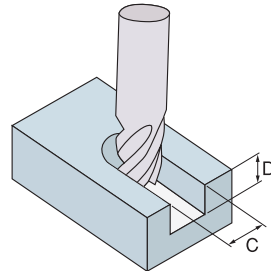

	Standard specification	High-power specification
Spindle speed	1400 rpm	1400 rpm
Cutting speed	141 m/min (5551 ipm)	141 m/min (5551 ipm)
Cutting width (C)	32 mm (1.26")	32 mm (1.26")
Cutting depth (D)	5 mm (0.2")	5 mm (0.2")
Feed rate	1000 mm/min (39.37 ipm)	1200 mm/min (47.24 ipm)
Feed per tooth	0.357 mm/tooth (0.014"/tooth)	0.4 mm/tooth (0.016"/tooth)
Cutting amount	160 cm ³ /min (9.6cu-inch/min)	192 cm ³ /min (11.5cu-inch/min)
Spindle motor load	103 %	65 %

Side cutting

φ16×4t

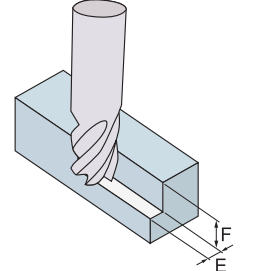

	Standard specification	High-power specification
Spindle speed	4000 rpm	6000 rpm
Cutting speed	200 m/min (7874 ipm)	300 m/min (11811 ipm)
Cutting width (E)	1.5 mm (0.059")	2 mm (0.08")
Cutting depth (F)	30 mm (1.18")	24 mm (0.94")
Feed rate	2800 mm/min (110.24 ipm)	6000 mm/min (236.22 ipm)
Feed per tooth	0.175 mm/tooth (0.007"/tooth)	0.25 mm/tooth (0.01"/tooth)
Cutting amount	126 cm ³ /min (7.6cu-inch/min)	288 cm ³ /min (17.3cu-inch/min)
Spindle motor load	64 %	57 %

MITSUBISHI

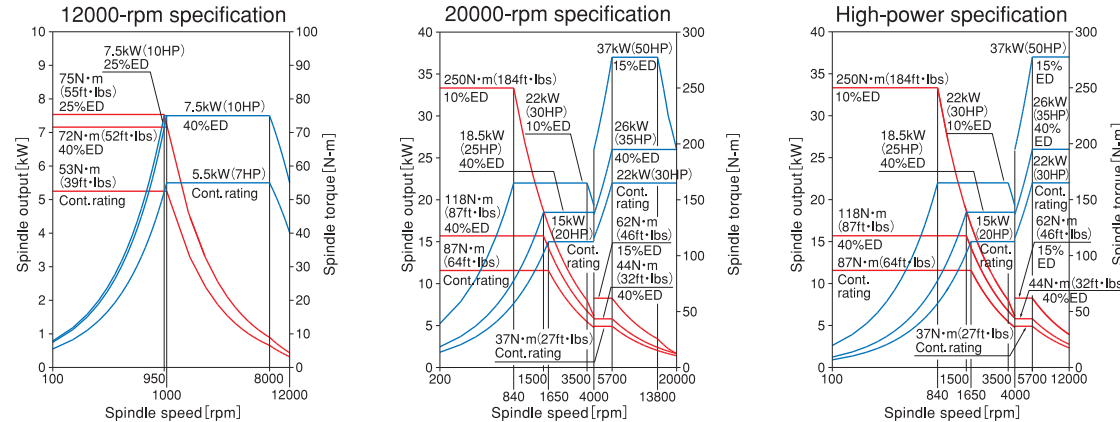

FANUC

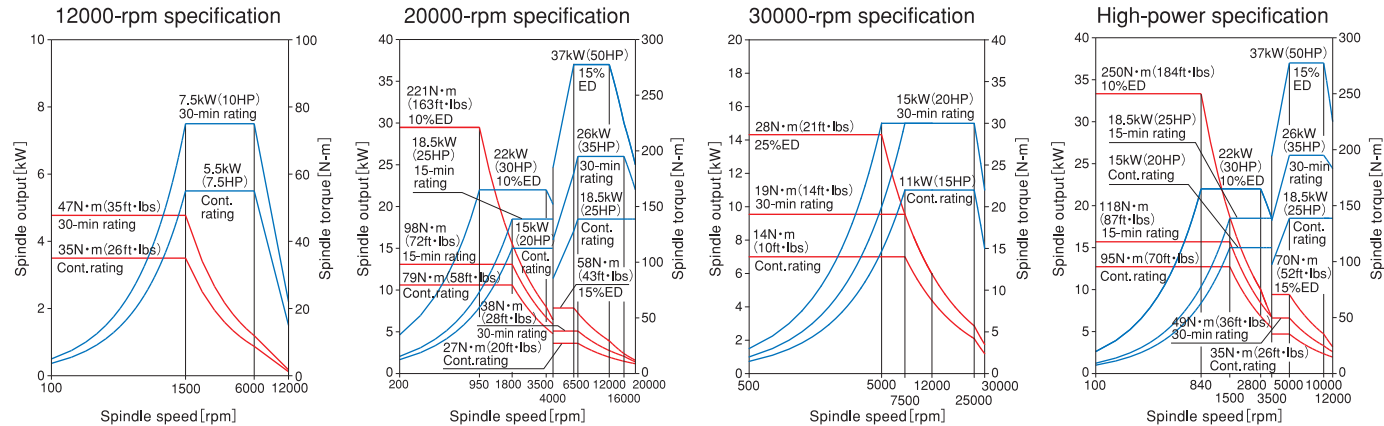

● For VP400 and VP600, the 12000-rpm specification is standard specification. For VP500-2APC, the high-power specification is standard specification.

High-accuracy motion characteristic proved by the data

Lost Motion Measurement Data (Actual Measurement Value)

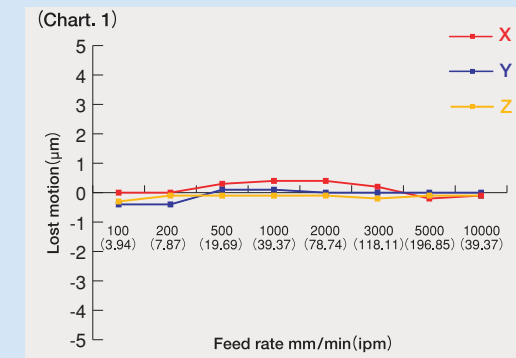

Minute Feed Measurement Data (Actual Measurement Value)

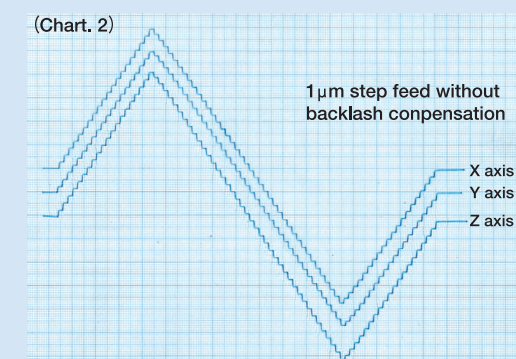

The data obtained under the OKK's internal testing conditions are shown here. The data obtained may vary with status of the machine.

Cellular phone (Machining of slightly different depth)

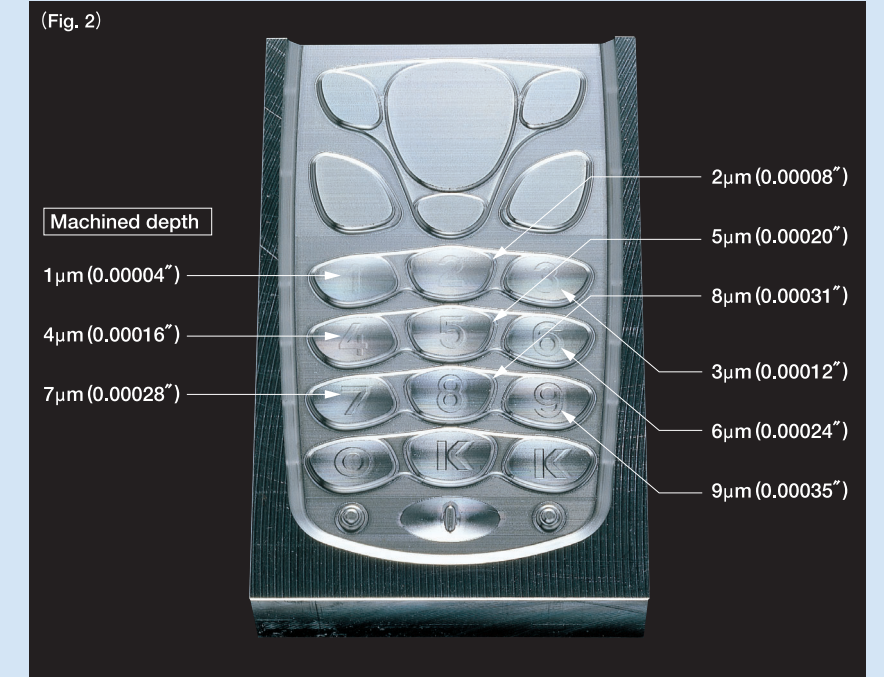

Model: VP400
Machined time: 3 hours
Workpiece size: 80 × 50 × 15 mm (3.15" × 1.97" × 0.59")
Spindle speed: 12000 rpm
Feed rate: 600 to 4000 mm/min (23.62 to 157.48 ipm)
Workpiece material: NAK80 (HRC40)
Type of tool used: R2 to R0.5 ball end mill

Listed data may not be attainable due to cutting conditions and other circumstances.

Circular Cutting Accuracy (Fig. 3)

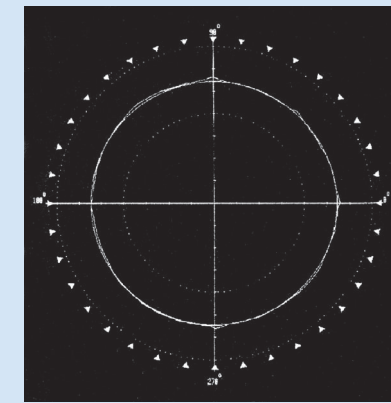

F500: 2.4 μm (19.69 ipm: 0.000094")

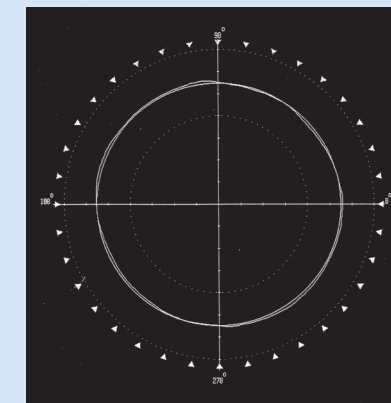

F5000: 2.6 μm (196.85 ipm : 0.000102")

	Tolerance	Actual value	
Straightness per full stroke : μm (inch)	X-Y	VP400 : 5 (0.0002") VP600 : 5 (0.0002")	VP400: X2 (0.00008") Y1 (0.00004") VP600: X4 (0.00016") Y2 (0.00008")
	Y-Z	5 (0.0002")	2 (0.00008")
	Z-X	5 (0.0002")	2 (0.00008")
Perpendicularity : μm (inch)	X-Y	5 μm/300mm (0.0002"/11.81")	2 (0.00008")
	Y-Z (full stroke)	8 (0.00031")	4 (0.00016")
	Z-X (full stroke)	8 (0.00031")	2 (0.00008")
Positioning accuracy per full stroke : μm (inch)	X	±2.0 (±0.00008")	±0.5 (±0.000020")
	Y	±2.0 (±0.00008")	±0.6 (±0.000024")
	Z	±2.0 (±0.00008")	±0.7 (±0.000028")
Positioning repeatability per full stroke : μm (inch)	X	±1.0 (±0.00004")	±0.4 (±0.000016")
	Y	±1.0 (±0.00004")	±0.3 (±0.000012")
	Z	±1.0 (±0.00004")	±0.2 (±0.000008")
Spindle runout on table surface (for 300mm (11.81") distance)	X-axis direction	8 (0.00031")	3 (0.00012")
	Y-axis direction	8 (0.00031")	1 (0.00004")
Spindle runout : μm (inch) (with a test bar mounted)	At base	3 (0.00012")	1 (0.00004")
	At 300mm (11.81")	12 (0.00047")	8 (0.00031")
Circularity : μm (inch) φ250mm, F500 (9.84", 19.69 ipm)	CW	5 (0.00020")	2.4 (0.000094")
	CCW	5 (0.00020")	2.6 (0.000102")
Spindle vibration value : μm (inch)	X Y direction	3 (p-p)	

NOTES

- ※ The values indicated above are of the standard specification machine having no linear scale.
- ※ The sample data above was obtained in the short-time processing. The results may vary in the continuous processing.
- ※ The sample data above was obtained under the Nidec OKK's internal cutting test conditions. The results may vary with the tools and fixtures used for processing.

VP 400 VP 600

● 2APC Specification

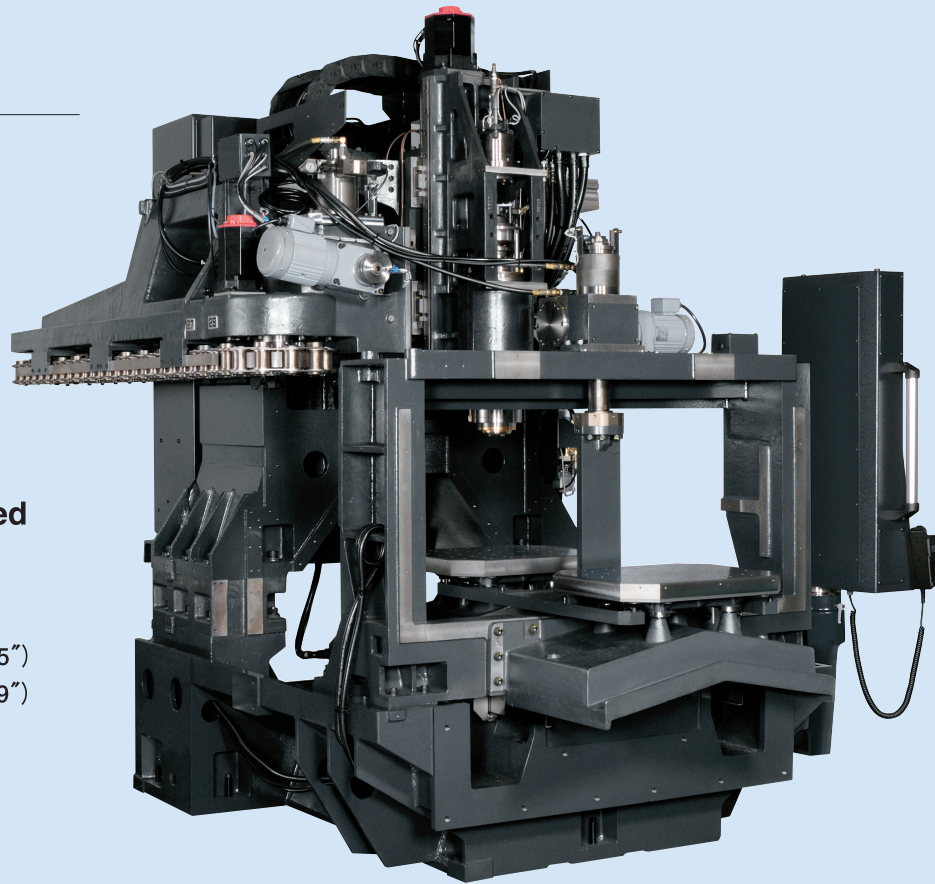

Realizes the pallet change in the shortest time in its class and the largely reduced non-cutting time

Pallet size

- VP400 : 500×400mm (19.69"×15.75")
- VP600 : 800×500mm (31.50"×19.69")



● Automatic Pallet Changer

Nidec OKK's original cam-driving type pallet changer realizes the pallet exchange in the shortest time in the class i.e. 5.0 seconds on VP400 and 8.0 seconds on VP600.

Sample Cutting Data

43% reduction of non-cutting time
(Comparison with our previous model)

- Acceleration 0.7G(X)
- Rapid traverse rate 48 m/min (1890 ipm)
- ATC time 1.2s(Tool-to-Tool)
- APC time 8s(VP600)

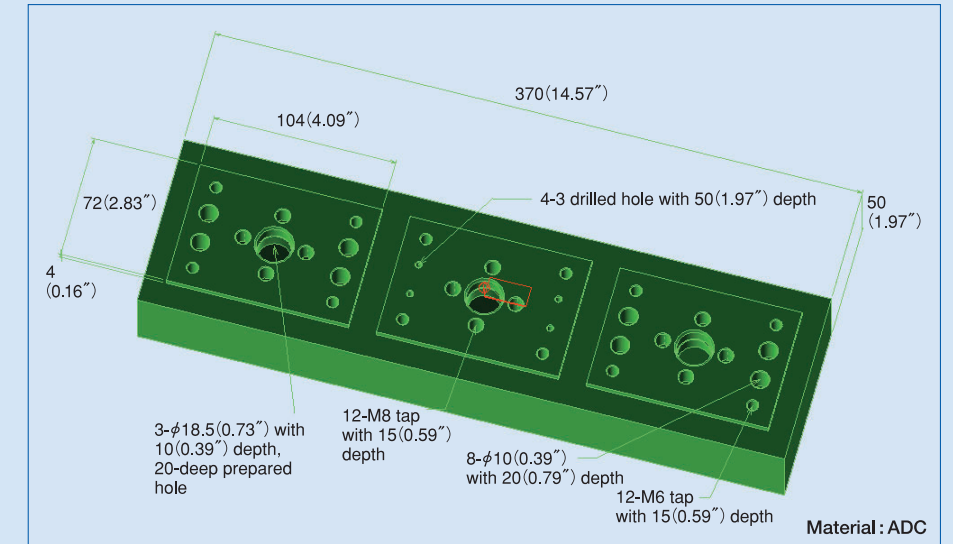

	Actual cutting time	Positioning	ATC	APC	Total	Difference in time
VP600	107.1	91.9	43.4	8.0	250.4	
Previous model	107.1	156.8	74.0	20.0	357.9	107.5

Unit: sec

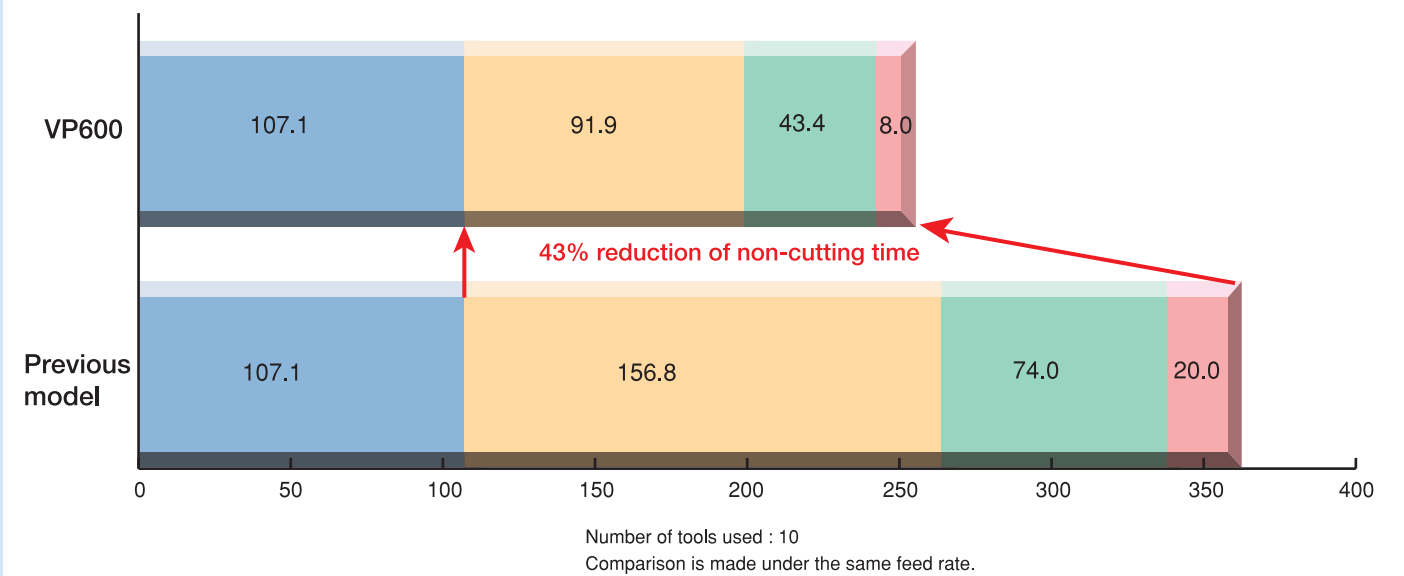

● The machines in the photographs of this brochure may include optional accessories.

Nidec OKK's Dedicated Control Functions

Programming Support Function

Program Editor

It enables editing of the programs in the NC memory, data server (or hard disc) and memory card. It also enables managing the programs i.e. copying, deleting, changing the program name, etc.

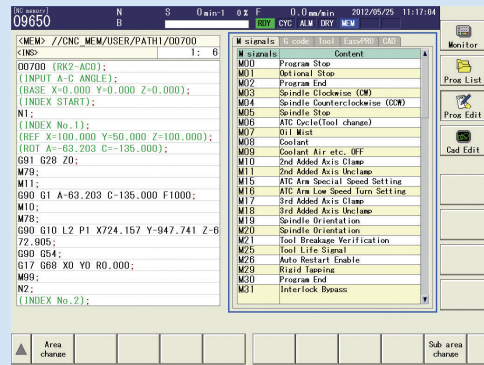

Setup Support Function

Tool Support

You can manage each tool's various information such as the tool name, schematic and offset number comprehensively through a single screen. It contains the functions that are convenient for the setup operation. For example the tool measurement is also available by just switching the menu.

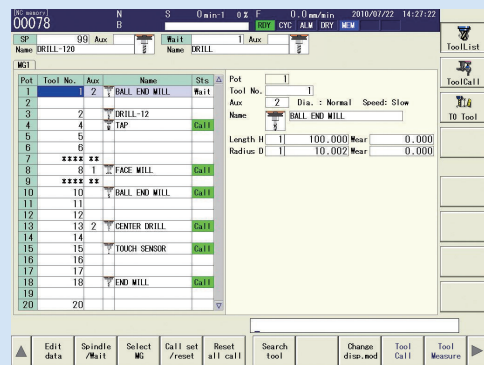

T0 Software (Option)

This screen enables the simple manual measurement using the touch sensor (option: T1-A or T1-B). You can move the sensor to the desired measuring point by handle mode then the machine starts the automatic measurement after the sensor contacts the workpiece. You can set the results of the measurement as the data for the desired workpiece coordinate system and tool offset number through the single key operation.

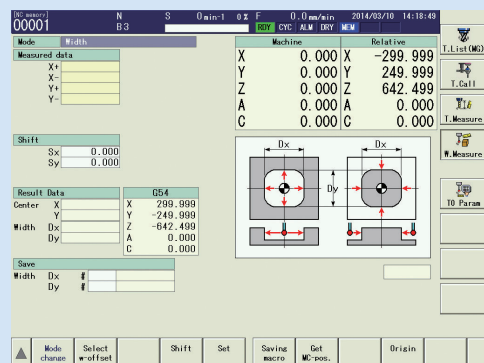

High-efficiency Control Technologies

Hyper HQ Control (Option)

High-speed processing is enabled by improved capability of processing fine line segment toolpaths.

<N830 capability of processing fine line segments>

Type	Fine line segment data processing speed (m/min)	Instruction method
Without Hyper HQ control	16.8(0.66 ipm)	
Hyper HQ control mode I	33.7(1.32 ipm)	ON : G5P1 OFF : G5P0
Hyper HQ control mode II	168(6.61 ipm)	ON : G5P2 OFF : G5P0

<F31i capability of processing fine line segments>

Type	Fine line segment data processing speed (m/min)	Instruction method
Without Hyper HQ control	15.0(0.59 ipm)	
Hyper HQ control A mode	30.0(1.18 ipm)	ON : G5.1Q1 OFF : G5.1Q0
Hyper HQ control B mode	150(5.91 ipm)	ON : G5.1Q1 OFF : G5.1Q0

The above values show (theoretical) maximum speeds for processing 1-mm-segment blocks construction a straight line. Actual processing speeds depend on the machine and NC data.

HQ Tuner (Option)

The HQ tuner provides the programmer a 10-step adjustment of parameters for hyper HQ control in accordance with processing conditions. It adjusts the hyper HQ control in accordance with the current process. For example, during roughing routines the programmer can place a higher priority on speed and in finishing routines a higher priority on dimensional accuracy at corners and circular arcs.

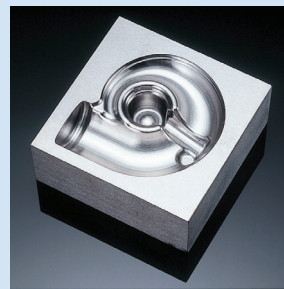

Network Function

Data Server (Option for F31i/F32i)

Large machining programs can be transferred to the data server through the network connected to the host computer at high speed. The transferred machining programs are executed as the main program or the sub program called up with the M198.

Hard Disc Operation (N830 Standard Function)

Large machining programs can be transferred to the hard disc installed in the machine through the network connected to the host computer at high speed. The transferred machining programs are executed as the main program or the sub program.

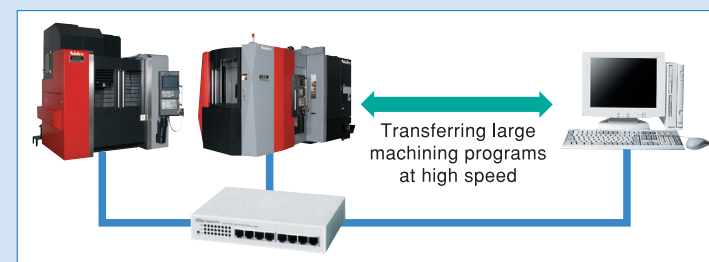

Main Specifications

Item	VP400	VP600
Travel on X axis (Saddle:right/left)	600mm(23.62")	1120mm(44.09")
Travel on Y axis (Table:back/forth)	410mm(16.14")	610mm(24.02")
Travel on Z axis (Spindle head:up/down)	460mm(18.11")	460mm(18.11")
Distance from table top surface to spindle nose	150~610mm(5.91"~24.02")	150~610mm(5.91"~24.02")
Distance from column front to spindle center	620mm(24.41")	740mm(29.13")
Table work surface area (X-axis direction × Y-axis direction)	900×410mm(35.43"×16.14")	1300×610mm(51.18"×24.02")
Max. workpiece weight loadable on table	500kg(1100 lbs)	1200kg(2640 lbs)
Table work surface configuration (Number and nominal dimension of T slots and spacing)	Three 18-mm(0.71") T slots with 125-mm(4.92") pitch	Five 22-mm(0.87") T slots with 125-mm(4.92") pitch
Height from floor level to table work surface	800mm(31.5")	850mm(33.46")
Spindle speed	100~12000rpm	100~12000rpm
Number of spindle speed shift steps	Stepless	Stepless
Spindle nose (nominal number)	7/24 taper No. 40	7/24 taper No. 40
Spindle bearing bore diameter	φ65mm(2.56")	φ65mm(2.56")
Rapid traverse rate	48 m/min (X and Y axes), 36 m/min (Z axis)	48 m/min (X and Y axes), 36 m/min (Z axis)
Cutting feed rate	1(0.04)~36000mm/min (1417ipm)*1	1(0.04)~36000mm/min (1417ipm)*1
ATC (Automatic Tool Changer)		
Type of tool shank (Nominal number)	JIS B 6339 BT40	JIS B 6339 BT40
Type of pull stud (Nominal number)	MAS 403 P40T-1	MAS 403 P40T-1
Tool storage capacity	20 tools	20 tools
Maximum tool diameter	φ110(4.33")	φ110(4.33")
Maximum tool length (from the gauge line)	300mm(11.81")	300mm(11.81")
Maximum tool weight	7kg(15.4 lbs)	7kg(15.4 lbs)
Tool selection method	Memory random method	Memory random method
Tool changing time (tool-to-tool)	1.2 s	1.2 s
Tool changing time (cut-to-cut)	3.8 s	3.8 s
Motor		
Spindle motor (30-min rating/continuous rating)	MITSUBISHI 7.5/5.5kW (10/7.5HP) FANUC 7.5/5.5kW (10/7.5HP)	7.5/5.5kW (10/7.5HP) 7.5/5.5kW (10/7.5HP)
Feed motors	MITSUBISHI X/Y:2.0/Z:3.5kW (2.7/4.7HP) FANUC X/Y/Z: 4.5kW (6.0HP)	X/Y:2.0/Z:3.5kW (2.7/4.7HP) X/Y/Z: 4.5kW (6.0HP)
Coolant pump motor	0.4kW (0.5HP)	0.4kW (0.5HP)
Motor for spindle head oil cooler pump	0.4kW (0.5HP)	0.4kW (0.5HP)
Motor for workpiece flushing gun	1.1kW (1.5HP)	1.1kW (1.5HP)
Motor for magazine	MITSUBISHI 1.5kW (2.0HP) FANUC 1.4kW (1.9HP)	1.5kW (2.0HP) 1.4kW (1.9HP)
Required power supply		
Power supply	MITSUBISHI 24 kVA FANUC 23 kVA	MITSUBISHI 24 kVA FANUC 23 kVA
Supply voltage	200V ±10% 50/60Hz ±1Hz 220V ±10% 60Hz ±1Hz	200V ±10% 50/60Hz ±1Hz 220V ±10% 60Hz ±1Hz
Supply frequency	50/60 ±1 60 ±1	50/60 ±1 60 ±1
Compressed air supply pressure	0.4~0.6MPa (57.1~85.7psi)	0.4~0.6MPa (57.1~85.7psi)
Air supply flow rate (atmospheric pressure)	400L/min (106gpm) (ANR)	400L/min (106gpm) (ANR)
Spindle cooling oil tank capacity	50 L (13.2gal)	50 L (13.2gal)
Coolant tank capacity	280 L (74gal)	280 L (74gal)
Machine height (from floor level)	2746mm (108.11")	2796mm (110.08")
Floor space required for operation (left-to-right × depth)	2016×2690mm (79.37"×105.91")	2516×3100mm (99.05"×122.05")
Required floor space incl. maintenance area (left-to-right × depth)	3000×3300mm (118.11"×129.92")	3500×3700mm (137.80"×145.67")
Machine weight	8000kg (17600 lbs)	10500kg (23100 lbs)
Environmental temperature	5~40°C	5~40°C

*1 : Under the HQ or Hyper HQ control.
*2 : When the tool storage capacity is 40 or more, maximum diameter of the tools is restricted to 82mm and the address fixed method is used for selection of tools.
*3 : Inform us of the desired manufacturer1 and model.

Standard Accessories

Item	Q'ty
Lighting unit (two LED lamps)	1 set
Coolant unit (Separate type coolant tank)	1 set
Safety door rock	1 set
Splash guard (Overall machine cover)	1 set
X/Y axes slideway protection cover	1 set
Spindle head cooling oil temperature controller	1 set
Coil-type chip conveyor (including the reverse rotation function)	1 set
Air blower	1 set
Signal lamp (3-lamp type including buzzer alarm)	1 set
Workpiece flushing gun	1 set
Automatic grease supply unit	1 set
Automatic power off (at M02/M30)	1 set
Leveling block	1 set
Parts for machine transportation	1 set
Electrical spare parts (fuses)	1 set
Instruction manual	1 copy
Electrical instruction manual (operating manual, maintenance instruction manual, parts list, and hardware diagrams)	1 copy
Top cover	1 set

Special Accessories (Option)

Item	Contents
High-speed spindle	20000rpm MITSUBISHI 37/26/22kW (50/35/30HP) (15%/40min/continuous) FANUC 37/26/18.5kW (50/35/25HP) (15%/30min/continuous) 30000rpm 15/11kW (20/15HP) (30min/continuous) (HSK-E40)
Compatibility with two-face locking tool	BBT, HSK
Increased spindle driving motor power	MITSUBISHI 37/26/22kW (50/35/30HP) (15%/40%/continuous) FANUC 37/26/18.5kW (50/35/25HP) (15%/30min/continuous)
Tool storage capacity	30, 40, 60, 80, 120 tools *2
Pallet changer	Direct-turn type
Lift-up type chip conveyor	Hinged type / Scraper type / Scraper type with floor magnet / Backwashing filtration type for aluminum / Backwashing filtration type for aluminum and casting Chip
Application of oil hole holder	Nikken / BIG / Others *3
Application through-spindle	2 MPa / 7 MPa (280/1000 psi)
Cartridge for Automatic lubricating unit	
Oil mist, air blower	
Automatic splash guard operation	
NC rotary table	Rotary table type *3
Coolant cooler	
Mist collector	
Touch sensor system T0 (Manual)	Workpiece measurement, Tool length/diameter measurement
Touch sensor system T1 (Automatic)	Workpiece measurement, Tool length/diameter measurement Tool break detection
Tool breakage detection with limit switches	
Linear scale	0.1 μm (0.000004") absolute position detection for X, Y and Z axes
Magazin operation panel	

Standrad Specification(VP400/VP600)

Main Dimensions of the Machine () VP600 dimensions

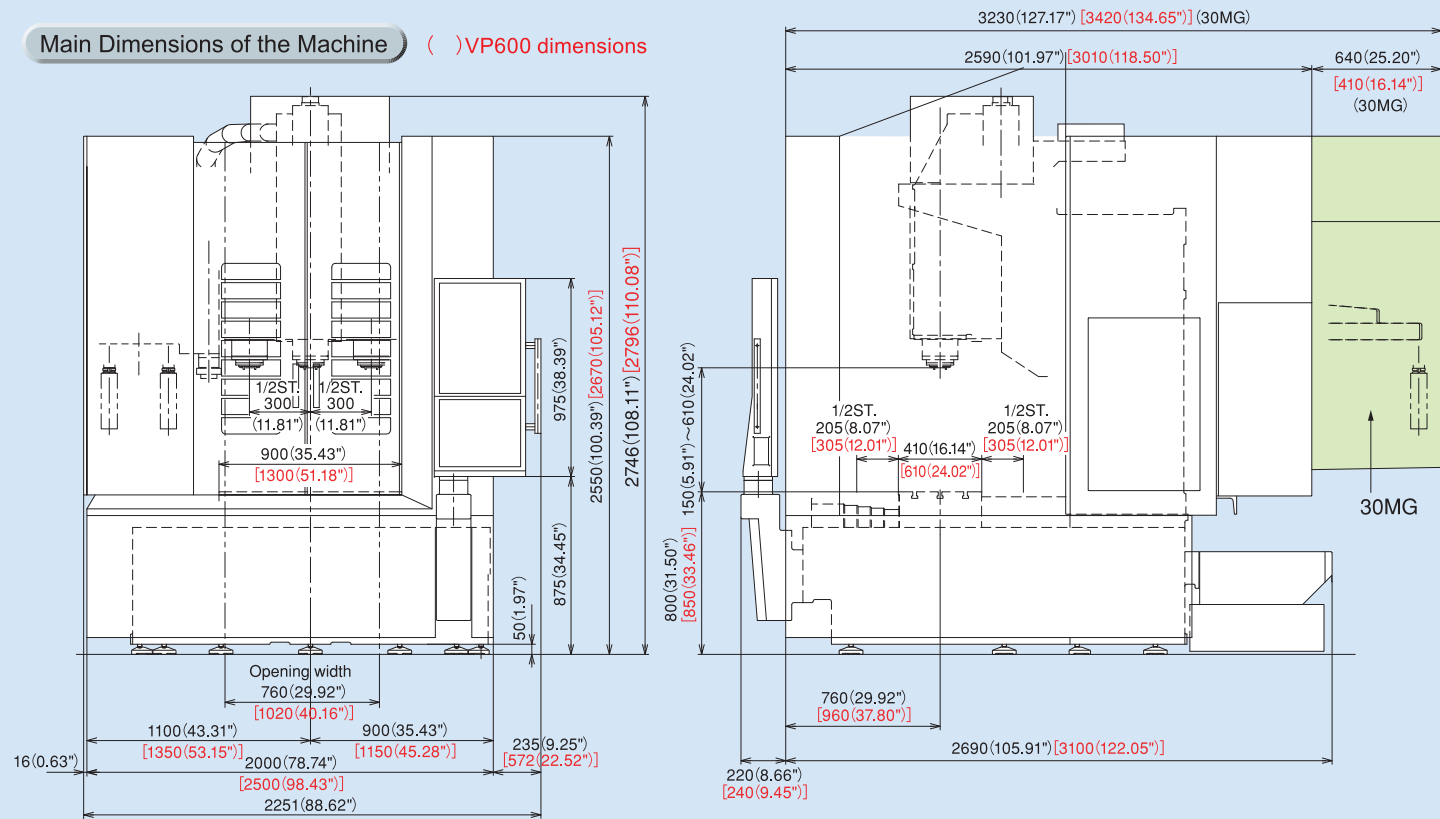

Floor Space

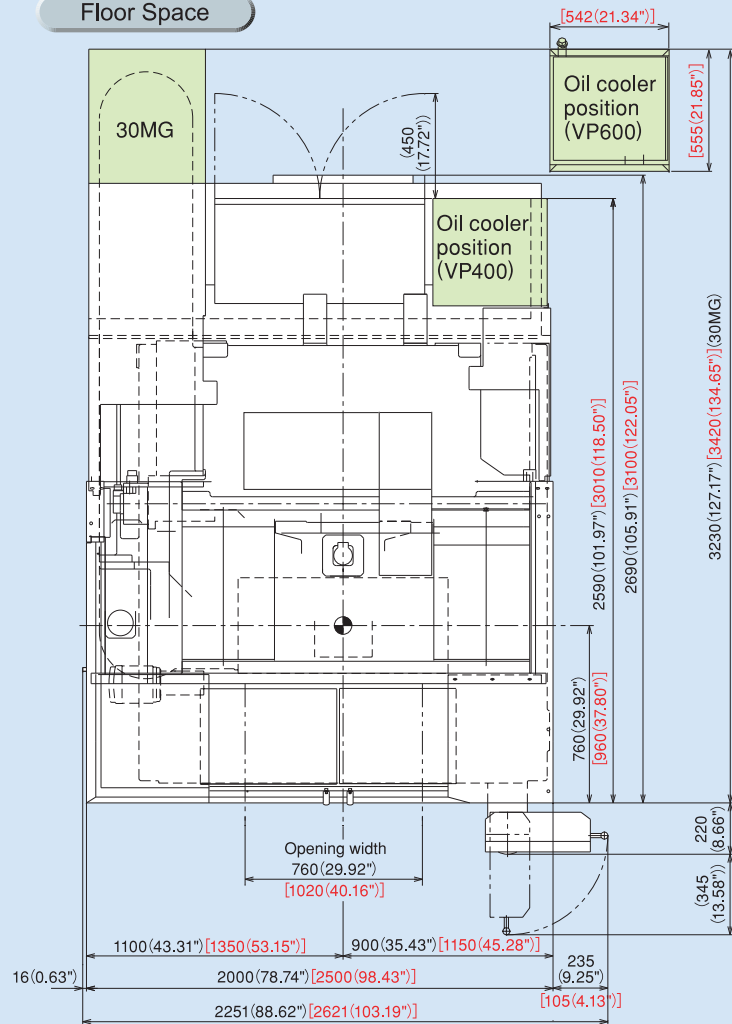

Table

VP400

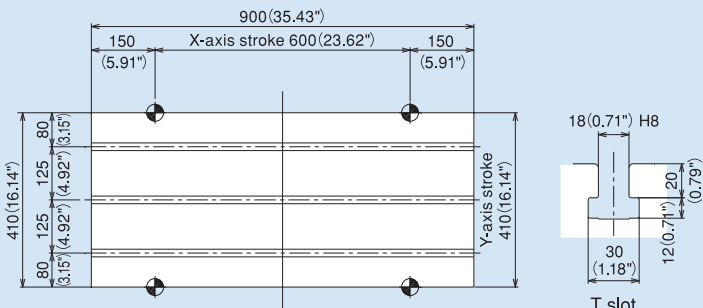

VP600

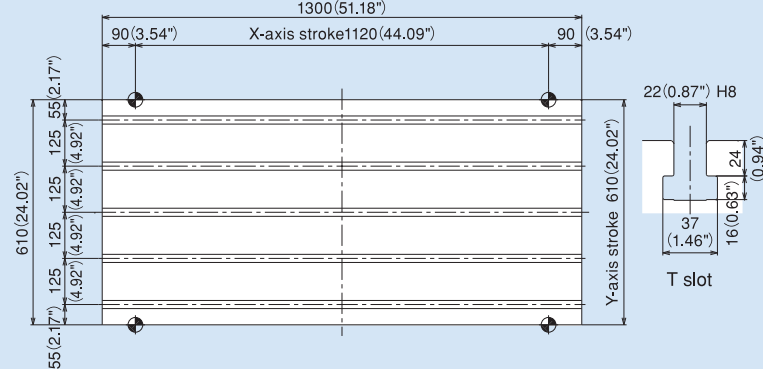

APC Specification(VP400/VP600)

Main Dimensions of the Machine () VP600 dimensions

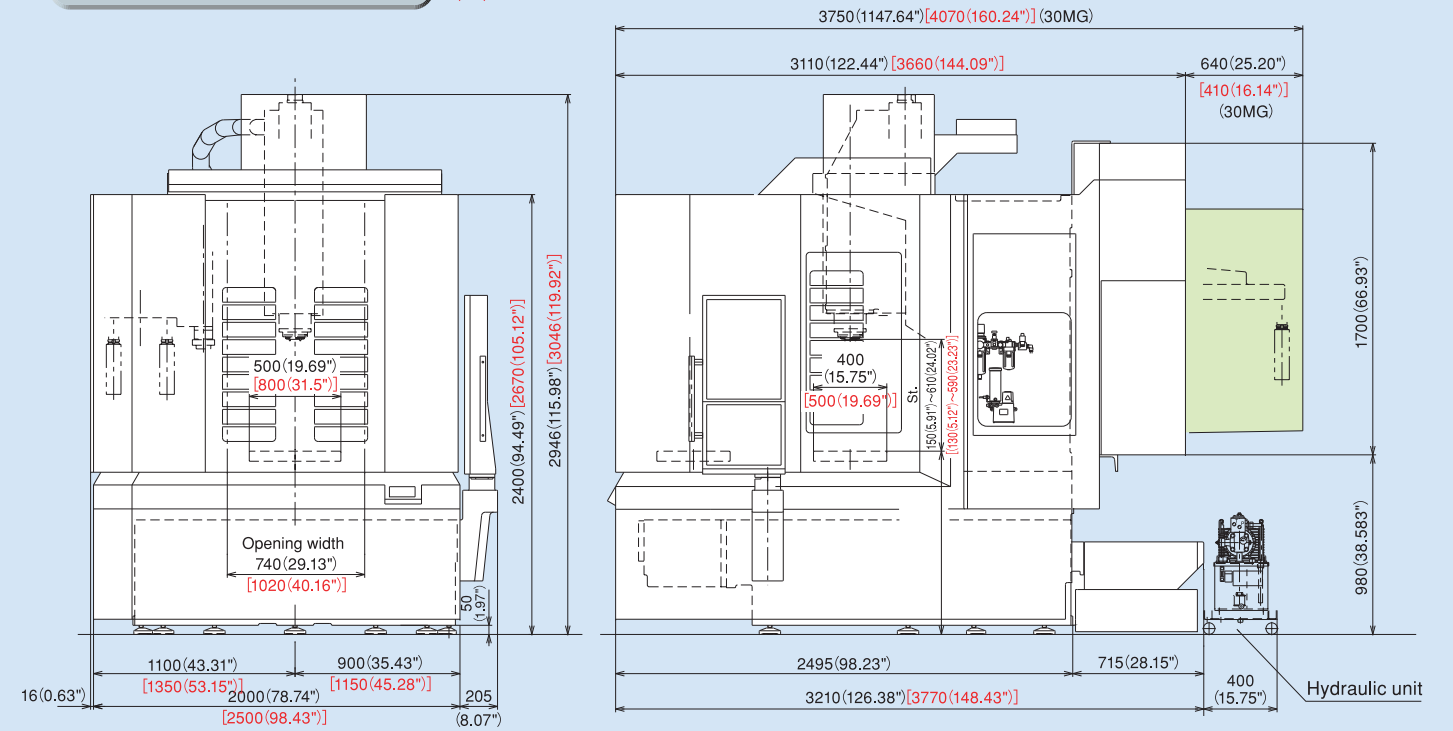

Floor Space

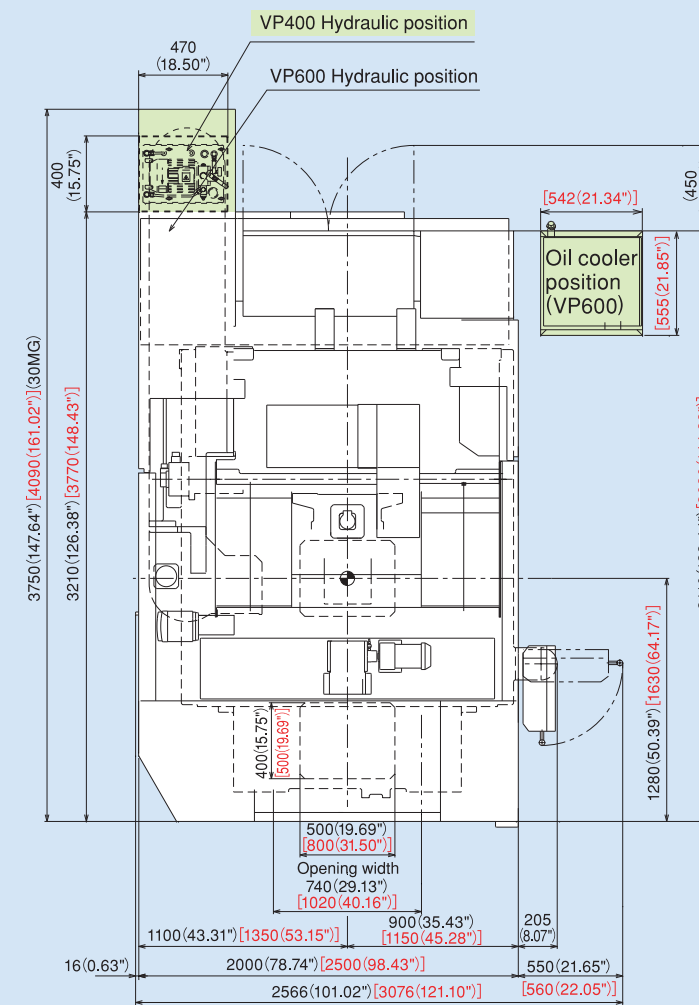

Pallet

VP400

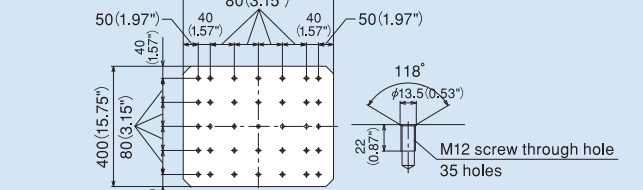

VP600

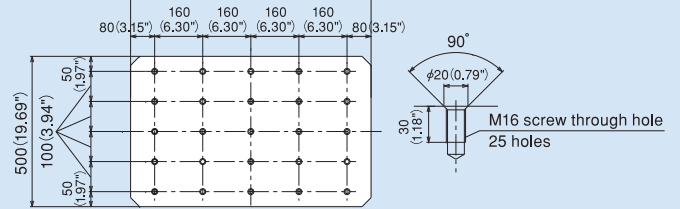

Item	VP400	VP600
Pallet changing method	Direct-turn method	
Pallet size	500mm×400mm(19.69"×15.75")	800mm×500mm(31.50"×19.69")
Pallet top surface machining	M12 taps	M16 taps
Max. weight loadable on pallet	300 kg(661 lbs)	500 kg(1102 lbs)
Pallet positioning method	4 taper cones	
Pallet changing time	5.0 s	8.0 s
Machine height	2946mm(115.98")	3046mm(119.92")
Required floor space (left-to-right × depth)	2016mm×3210mm (79.37"×126.38")	2516mm×3770mm (99.06"×148.43")
Machine weight	9500kg(20900 lbs)	12500kg(27600 lbs)

CONTROLLER

N830 (Windows 8-installed Open CNC)

Standard Specification

No. of controlled axes: 3 axes (X, Y, Z)
No. of simultaneously controlled axes: 3 axes
Least input increment: 0.001 mm / 0.0001"
Max. programmable dimension:
±99999.999 mm / ±9999.9999"
Inch / Metric conversion: G20 / G21
Program format: Melder standard format
(M2 / M0 format needs to be instructed separately.)
Decimal point input I / II
Absolute / Incremental programming: G90 / G91
Program code: ISO / EIA automatic discrimination
Least control increment: 1nm
Positioning: G00
Linear interpolation: G01
Circular interpolation: G02 / G03
(Including radius designation)
Unidirectional positioning
Helical interpolation
Cutting feed rate: 5.3-digit F-code, direct designation
One digit F-code feed
Rapid traverse override: 0 / 1 / 10 / 25 / 50 / 100%
Cutting feed rate override: 0 to 200% (every 10%)
Feed rate override cancel: M49 / M48 (cancel)
Rigid tap cycle: G74, G84
Manual handle feed:
Least input increment: ×1, ×10, ×100 / graduation
Dwell: G04
Part program storage capacity: 1280m[500KB]
No. of registered programs: 1000
Part program editing
Background editing: Possible to program or edit the
machining program while NC machining is executed.
Buffer modification
Color touch-panel display (15" LCD / QWERTY key MDI)
Integrating time display
Clock function
User definable key
MDI (Manual Data Input) operation
Menu list
Parameter / Operation guidance
Alarm guidance
Ethernet interface
SD card / USB memory interface
Operation inside display unit with high-speed program server
Operation with SD card / USB memory
Spindle function:
Direct designation of spindle speed with 5-digit S-code
Spindle speed override: 50 to 150% (every 5%)
Tool function: Direct designation of called tool number
with 4-digit T-code
ATC tool registration
Miscellaneous function: Designation with 3-digit M-code
Multiple M-codes in 1 block: Maximum 3 codes in 1 block
(Maximum 20 settings)
Tool length offset: G43, G44, G49 (cancel)
Tool position offset: G45 to G48
Cutter compensation: G38 to G42
Tool offset sets: Total 200 sets
Tool offset memory II :
tool geometry (length / diameter) and wear offset
Machine coordinate system: G53
Coordinate system setting: G92
Automatic coordinate system setting

Workpiece coordinate system: G54 to G59
Local coordinate system: G52
Manual reference position return
Automatic reference position return
2nd to 4th reference position return:
G30 P2 to P4
Reference position return check : G27
Optional block skip: / n (n: 1 to 9)
Single block
Dry run
Machine lock
Z-axis feed cancel
Miscellaneous function lock
3D solid program check
Graphic display check
Program number search
Sequence number search
Sequence number comparison and stop
Program restart function
Cycle start
Feed hold
Manual absolute
(ON / OFF setting with PLC parameter)
Auto restart
Program stop: M00
Optional stop: M01
Machining time computation
Automatic operation handle interruption
Manual numerical command
Sub program control: M98, M99
Canned cycle: G73, G74, G76, G81 to G89,
G80 (Cancel)
Linear angle designation
Circular cutting: G12, G13
Parameter mirror image
Programmable mirror image:
G51.1, G50.1 (Cancel)
User macro and user macro interruption
Variable command: total 700 sets
Programmable coordinate system rotation:G68,
G69 (Cancel)
Parameter coordinate system rotation
Corner chamfering / corner R:
Insert between straight line-straight line /
straight line-circle blocks
Programmable data input: G10 / G11 (Cancel)
Automatic corner override
Exact stop check / mode
Playback
Memory pitch error compensation
Backlash compensation
Skip function: G31
Manual tool length measurement
Tool life management II : 200 sets
External search
Emergency stop
Data protection key
NC alarm display
Machine alarm message
Stored stroke limit I / II
Load monitor
Self-diagnosis
Absolute position detection

Optional Specification

Additional one axis control:
name of axis (A, B, C, U, V, W)
Additional two axes control:
name of axis (A, B, C, U, V, W) Note
Simultaneously controlled axes: 4 axes
Simultaneously controlled axes: 5 axes Note
Least input increment: 0.0001 mm / 0.00001 inch
Program format: M2 / M0 format
Spiral / Conical interpolation
Cylindrical interpolation
Hypothetical axis interpolation
NURBS interpolation
(Hyper HQ control mode II is required)
Handle feed 3 axes: Standard pulse handle is removed.
Inverse time feed
Part program storage capacity: 2560m[1MB]
(No. of registered programs: total 1000)
Part program storage capacity: 5120m[2MB]
(No. of registered programs: total 1000)
Color touch-panel display (19" LCD / Software key MDI)
RS232C interface: RS232C-1CH
Computer link B: RS232C
Spindle contour control (Spindle position control)
3-dimensional cutter compensation
Tool offset sets: total 400 sets
Tool offset sets: total 999 sets
Addition of workpiece coordinate system (total 96 sets):
G54.1 P1 to G54.1 P96
Addition of workpiece coordinate system (total 300 sets):
G54.1 P1 to G54.1 P300
Tool retract and return
Scaling: G51, G50 (Cancel)
Pattern rotation
Chopping function
Special canned cycles: G34, G35, G36, G37
Additional tool life management sets: total 400 sets
Additional tool life management sets: total 999 sets

Original Nidec OKK Software

Integrated machining support system STD
Tool support STD
Program Editor STD
EasyPRO STD
Work Manager Opt
HQ control STD
Hyper HQ control mode I Opt
Hyper HQ control mode II Opt
Soft Scale II m STD
WinGMC8 STD
Cycle Mate Opt
Touch sensor T0 software Opt
Soft CCM (Tool failure detection system) Opt
Soft AC (Adaptive control unit) Opt
Automatic restart at tool damage Opt

STD : Standard Opt : Option

Note: N850 (Windows 8-installed Open CNC)

F31-IB Plus (WindowsCE-installed Open CNC)

Standard Specification

No. of controlled axes: 3 axes (X, Y, Z)
No. of simultaneously controlled axes: 3 axes
Least input increment: 0.001mm / 0.0001"
Max. programmable dimension:
+999999.999mm/+39370.0787"
Absolute / Incremental programming: G90 / G91
Decimal point input/
Pocket calculator type decimal point input
Inch / Metric conversion: G20 / G21
Program code: ISO / EIA automatic discrimination
Program format: FANUC standard format
FS15 tape format
Nano interpolation (internal)
Positioning: G00
Linear interpolation: G01
Circular interpolation: G02 / G03 (CW/CCW)
(Including radius designation)
Helical interpolation
Unidirectional positioning: G60
Cutting feed rate: 6.3-digit F-code, direct designation
Rapid traverse override: 0/1/10/25/50 / 100%
Cutting feed rate override: 0 to 200% (every 10%)
Feed rate override cancel: M49/M48
Rigid tapping: G84, G74 (Mode designation: M29)
Manual handle feed:
Least input increment ×1, ×10, ×100/graduation
Dwell: G04
One-digit F code feed
inverse time feed
Part program storage capacity:
total 10240m[4MB] (total 1000 programs)
Part program editing
Background editing:
Possible to program or edit the machining
program while NC machining is executed.
Extended part program editing
15-inch color LCD/QWERTY key MDI
Clock function
MDI (manual data input) operation
Run hour and parts count display
Memory card/USB interface
Spindle function: Direct designation of spindle speed
with 5-digit S-code
Spindle speed override: 50 to 150% (every 5%)
Tool function: Direct designation of called tool
number with 4-digit T-code
ATC tool registration
Auxiliary function: Designation with 3-digit M-code
Multiple M-codes in 1 block: Maximum 3 codes in 1
block (Maximum 20 settings)
Tool length offset: G43, G44 / G49
Tool diameter and cutting edge R compensation:
G41, G42/ G40
Tool offset sets: total 400 sets
Tool offset memory C
Tool position offset
Automatic reference position return: G28 / G29
2nd reference position return: G30
Machine coordinate system: G53
Coordinate system setting: G92
Automatic coordinate system setting
Workpiece coordinate system:
G54 to G59 G54.1 P1 ~ P48

Local coordinate system: G52
Polar coordinate command: G15,G16
Manual reference position return
Reference position return check: G27
Optional block skip:/
Single block
Dry run
Machine lock
Z-axis feed cancel
Auxiliary function lock
Graphic function
Program number search
Sequence number search
Program restart
Cycle start
Feed hold
Manual absolute (ON/OFF with PMC parameter)
Auto restart
Program stop: M00
Optional stop: M01
Sequence number collation and stop
Sub program control
Canned cycle: G73, G74, G76, G80 to G89
Mirror image function parameter
Custom macro
Programmable mirror image
Programmable data input: G10
Automatic corner override
Manual Guide i (Basic)
Exact stop check / mode
Scaling: G50,G51
Additional custom macro common variables:1000
Coordinate system rotation:G68,G69
Optional chamfering / corner R
Playback
Memory pitch error compensation (interpolation type)
Backlash compensation for each rapid traverse and
cutting feed
Smooth backlash
Skip function
Tool life management: total 256 sets
Tool length manual measurement
Data protection key
NC alarm display / alarm history display
Machine alarm display
Stored stroke check 1
Stored stroke check 2
Load monitor
Self-diagnosis
Absolute position detection

Optional Specification

Additional one axis control:
name of axis (A, B, C, U, V, W)
Additional two axes control:
name of axis (A, B, C, U, V, W) ※1
No. of simultaneously controlled axes: 4 axes
No. of simultaneously controlled axes: 5 axes ※1
Least input increment: 0.0001mm / 0.00001"
Spiral / Conical interpolation
Cylindrical interpolation
Hypothetical axis interpolation
Involute interpolation
NURBS interpolation

Smooth interpolation
(Hyper HQ control B mode is required)
Handle feed 3 axes:Standard pulse handle is removed
Part program storage capacity:
total 20480m[8MB] (1000 in total)
Machining time stamp
Data server: ATA card (1GB)
Data server: ATA card (4GB)
RS232C interface: RS232C-1CH
Spindle contour control (Cs contour control)
Tool position offset
Tool offset sets: total 499 sets
Tool offset sets: total 999 sets
Addition of workpiece coordinate system (total 300 sets):
G54.1 P1 to P300
Optional block skip: Total 9
Manual handle interruption
Tool retract and return
Figure copy
Interruption type custom macro
Instruction of inclined plane indexing
Chopping
Manual Guide i (Milling cycle)
Addition of tool life management sets:
total 1024 sets
High-speed skip

Original Nidec OKK Software

Integrated machining support software
(incl. help guidance, etc.) STD
Tool support STD
Program Editor STD
EasyPRO STD
Work Manager Opt
HQ control STD
Hyper HQ control mode A Opt
Hyper HQ control mode B Opt
Hyper HQ varue kit ※2 Opt
Special canned cycle (including circular cutting) ... Opt
Cycle Mate F Opt
Soft Scale II m STD
Touch sensor T0 software Opt
Soft CCM (Tool failure detection system) Opt
Soft AC (Adaptive control unit) Opt
Automatic restart at tool damage Opt

STD : Standard Opt : Option

※1 : F31i-B5 Plus (WindowsCE-installed Open CNC)
※2 : Includes Data server: ATA card (1GB) and Hyper
HQ control mode B